

August 2019

Financially Motivated LMP Manipulation By Aggregators in Power Markets

Chaoyi Chen
University of Wisconsin-Milwaukee

Follow this and additional works at: <https://dc.uwm.edu/etd>



Part of the [Electrical and Electronics Commons](#)

Recommended Citation

Chen, Chaoyi, "Financially Motivated LMP Manipulation By Aggregators in Power Markets" (2019). *Theses and Dissertations*. 2167.

<https://dc.uwm.edu/etd/2167>

This Thesis is brought to you for free and open access by UWM Digital Commons. It has been accepted for inclusion in Theses and Dissertations by an authorized administrator of UWM Digital Commons. For more information, please contact open-access@uwm.edu.

FINANCIALLY MOTIVATED LMP MANIPULATION BY AGGREGATORS
IN POWER MARKETS

by

Chaoyi Chen

A Thesis Submitted in
Partial Fulfillment of the
Requirements for the Degree of

Master of Science
in Engineering

at

The University of Wisconsin-Milwaukee

August 2019

ABSTRACT

FINANCIALLY MOTIVATED LMP MANIPULATION BY AGGREGATORS IN POWER MARKETS

by

Chaoyi Chen

The University of Wisconsin-Milwaukee, 2019
Under the Supervision of Professor Lingfeng Wang

Renewable energy accounts for a sizeable share within modern power systems and aggregators of renewable generators play an important role in the electricity market. However, because renewable generators produce power intermittently, it is hard to monitor and supervise the behavior of the aggregators. There is a chance for aggregators to manipulate the locational marginal prices (LMPs) in the power market by curtailing generation in order to increase their profits.

In this thesis we propose a tri-level model that can quantify aggregators' potential profits. This model is based on both a real-time optimal dispatch and an LMP clearing procedure. With this model, the relationship between curtailment of generation and profits of aggregators was studied by using different backup generators in an IEEE 14-bus power system. At the same time, we found the most profitable point at which aggregators curtail generation. We also used the same IEEE 14-

bus power system to devise a resilience strategy to keep LMPs steady throughout the whole power system. This resilience strategy led to a decline in aggregators' motivation to manipulate LMPs in power markets.

In the study, we show that the aggregators can increase their profits through the curtailment of generation and this behavior can lead to significant LMP changes in the whole power system. The profit of aggregators can be different when the independent system operators (ISOs) use different generators to make up the financially motivated curtailment. Further, this thesis shows that aggregators have the potential to conduct financially motivated LMP manipulation in the power market and it can push ISOs to improve the related management rules.

TABLE OF CONTENTS

LIST OF FIGURES	vii
LIST OF TABLES	ix
LIST OF ABBREVIATIONS	x
ACKNOWLEDGEMENTS	xii
1 Introduction	1
1.1 Research Background	1
1.1.1 Modern Power System with Renewable Energy	1
1.1.2 Renewable Energy Aggregators	1
1.1.3 Power Market Operation	2
1.1.4 Economic dispatch	3
1.2 Literature Review	4
1.2.1 Arbitrage Study in Power Market	4
1.2.2 Economic Power Dispatch after LMP Manipulation	5
1.2.3 Locational Marginal Price	6
1.3 Thesis Objectives and Contributions	7
1.3.1 Research Objectives	7

1.3.2	Summary of Contributions	7
2	Tri-level Model of the Optimizing Curtailment Profit	9
2.1	Structure of the Tri-level Model	9
2.2	The Aggregator Behavior of the Generation Curtailment	12
2.3	Economic Power Dispatch.....	14
2.4	LMP Model Based on Generation Curtailment	16
3	Case Study	19
3.1	Data Set.....	20
3.2	Case 1 – All the Other Generators are Available.....	22
3.3	Case 2 –The Generators at Bus 3, 6, 8 are Available	26
3.4	Other cases	30
3.5	The most suitable curtailment strategy.....	37
3.5.1	Expectation Strategy.....	37
3.5.2	Robust Optimization.....	38
3.5.3	Comparison	40
4	Mitigation strategy against LMP manipulation by aggregators.....	42
5	Conclusion and Future Work	44
	Appendix.....	49
	Appendix A.....	49

Appendix B 50

LIST OF FIGURES

Fig. 2-1 Tri-level model for price manipulation.....	11
Fig. 2-2 The comparison of profits after the generation curtailment.....	12
Fig. 3-1 IEEE 14-bus power system.....	19
Fig. 3-2 The relationship between LMP and curtailment – generators at bus 2, 3, 6, 8 are available to make up the curtailment.....	23
Fig. 3-3 Profit caused by generation curtailment – generators at bus 2, 3, 6, 8 are available to make up the curtailment.....	23
Fig. 3-4 The LMP changes at different buses after the curtailment – generators at bus 2, 3, 6, 8 make up the curtailment.....	25
Fig. 3-5 The relationship between LMP and curtailment – generators at bus 3, 6, 8 are available to make up the curtailment.....	27
Fig. 3-6 Profit caused by generation curtailment – generators at bus 3, 6, 8 are available to make up the curtailment.....	27
Fig. 3-7 The LMPs at different buses before and after the curtailment – generators at bus 3, 6, 8 make up the curtailment.....	29
Fig. 3-8 LMP changes– case 3.....	31
Fig. 3-9 LMP changes– case 4.....	31
Fig. 3-10 LMP changes– case 5.....	31
Fig. 3-11 LMP changes– case 6.....	31
Fig. 3-12 LMP changes– case 7.....	31

Fig. 3-13 LMP changes– case 8.....	31
Fig. 3-14 LMP changes– case 9.....	32
Fig. 3-15 LMP changes– case 10.....	32
Fig. 3-16 LMP changes– case 11.....	32
Fig. 3-17 Profit changes– case 3.....	33
Fig. 3-18 Profit changes– case 4.....	33
Fig. 3-19 Profit changes– case 5.....	33
Fig. 3-20 Profit changes– case 6.....	33
Fig. 3-21 Profit changes– case 7.....	34
Fig. 3-22 Profit changes– case 8.....	34
Fig. 3-23 Profit changes– case 9.....	34
Fig. 3-24 Profit changes– case 10.....	34
Fig. 3-25 Profit changes– case 11.....	34
Fig. 3-26 The most profitable curtailment points in different cases.....	35
Fig. 3-27 The maximum profits of the aggregator in different cases.....	36
Fig. 3-28 The expectation profit of the aggregator with different curtailments.....	38
Fig. 3-29 The aggregator’s profit with different curtailments under robust optimization.....	39
Fig. 4-1 The 2-norm of LMP changes.....	43

LIST OF TABLES

Table 3-1 System information- generation outputs, original offer prices and generator capacities.....	21
Table 3-2 System information- loads.....	21
Table 3-3 Line capacities.....	22
Table 3-4 Different cases.....	30
Table 3-5 The compare of the expectation strategy and robust optimization.....	40

LIST OF ABBREVIATIONS

Indices

λ Locational marginal price (LMP) (in \$/MWh)

Constants

p Generation output (in MW) of generators

d Actual value of loads (in MW)

G Shifting factor matrix

B Pseudo inverse matrix of G

c Offer price (in \$/MWh) of generator

$\underline{\Delta p}, \overline{\Delta p}$ The lower and upper limits on the change of generations (in MW)

$\underline{f}, \overline{f}$ The lower and upper line limits (in MW)

$\overline{Pg_i}$ The upper generation limit at bus i (in MW)

ε The upper limit of generation curtailment by the aggregator (in MW)

p_c The possibility for each making up case c

Variables

α_i The generation curtailment caused by the aggregator (in MW) (positive value)

$\Delta\beta_l$ The opposite value of the extra generation at bus l to make up the curtailment (in MW)

$\Delta\gamma$ The combination of α_i and $\Delta\beta_l$

Δp The change in power output for generators (in MW)

λ^-, λ^+ Lagrange multipliers associated with LMP

μ^-, μ^+ Lagrange multipliers associated with the lower and upper bounds for the power flow of line

f Flow of system lines (in MW)

w_c^α The profit of the aggregator based on case c when the curtailment is α (in \$)

ACKNOWLEDGEMENTS

First of all, I would like to appreciate the help from my advisor, Dr. Lingfeng Wang. He has always provided me with professional and timely advices. His thoughtful and kind character has influenced me greatly. I am thankful to the time he spent in guiding me. I also want to thank Dr. Zhaoxi Liu. He has guided me throughout my thesis research by enabling me to make progress continuously. Whenever I met problems, he would discuss with me patiently and suggest possible solutions. Furthermore, I am grateful to Dr. David Yu and Dr. Wei Wei for their time and effort in serving as my defense committee members. Finally, I would like to thank my parents for sending me abroad and giving me the chance to do research here. I also appreciate all the help from my friends.

This work was supported in part by the National Science Foundation under Award ECCS1711617, and in part by the National Science Foundation Industry/University Cooperative Research Center on Grid-connected Advanced Power Electronic Systems (GRAPES) under Award GR-18-06.

1 Introduction

1.1 Research Background

1.1.1 Modern Power System with Renewable Energy

Power systems are grids to supply, transfer and use electricity. Traditional power systems are mainly composed of three parts: generation, transmission, and distribution system, in which the power generation is centralized. There are only few large power plants, including thermal power plants, hydropower plants, and nuclear power plants [1]. Electricity flows from generation systems to distribution systems through transmission lines. Most generation plants can be controlled.

With the development of technology and the more attention on renewable energy, modern power systems develop fast now. Generation units can be found in the distribution system, which is not centralized but distributed, including fuel cells and photovoltaic panels. However, because renewable energy power generation is intermitted, it is hard to be monitored and controlled.

1.1.2 Renewable Energy Aggregators

In the power system, it is hard to keep the balance of load demand and energy supply. Individual renewable energy generators cannot fulfill the need for distribution flexibility and safety. Instead, renewable energy aggregators can solve this problem. They are entities that aggregate the

load or generation units and in order to optimize the energy supply and power consumption technically and economically. Renewable energy aggregators aggregate in control decentralized renewable energy units to avoid system imbalance and push the development of renewable energy.

However, as for the aggregators, creating the algorithm of managing renewable energy in different places is difficult. From the perspective of the system operators, it is hard to monitor the power market with aggregators and reduce the market power of aggregators. Different from the traditional generation source, the generation controlled by aggregators cannot be verified. The unavailable time for generation in solar power plants cannot be scheduled or verified after the fact. Therefore, aggregators have the chance to curtail generation for manipulating bus prices and making profits without being noticed by the ISO [2].

1.1.3 Power Market Operation

Electricity is a special type of tradable product. It is used and produced simultaneously and the generation must meet the load demand exactly in the power grids. ISO (independent system operator) and RTO (regional transmission organizations) are responsible for the balance. They forecast and plan generation to ensure sufficient generation. There are nine ISOs and RTOs in North America which are noncommercial organizations and they manage the energy market. They are ‘day-ahead market’ and ‘real-time market’ respectively and both of them based on using

locational marginal price (LMP) [3]. In the day-ahead market, the generators submit their bids to ISOs and RTOs, based on varying costs for each hour or next operating day [4]. In the real-time market, ISOs and RTOs manage the changes of production and consumption throughout the day [4].

ISOs and RTOs optimize generation dispatch schedule considering system energy price, transmission congestion cost and the cost of marginal losses [5]. It was committed by all the market participants with the locational marginal price (LMP) which varied at each bus in the power grid based on the published prices from ISOs and RTOs. In the real-time market, the system operators dispatch generation to each generator based on the real-time system operating conditions [6]. Accordingly, generation and load are priced at each node in the grid.

1.1.4 Economic dispatch

In power system, generators should always response to the changes in load because they need to keep balance at all the time. Therefore, it is necessary to adjust the output of aggregators frequently. The aim of economic dispatch is to minimize the operation cost of the whole power system through determining the generation output from each generator [7]. The costs of producing a unit of electricity are different among generators and it also costs differently for the loss when they send generation to the load. The process of economic dispatch runs every few minutes to

choose the combination of generator set points that minimizes the whole cost and it is also subject to the line limits and generators' capacities [8].

In this thesis, because the generation at one bus was curtailed, other generators must produce the same amount of power to meet the same load demand. Therefore, ISOs should do the economic dispatch after the curtailment. We did not consider network loss and only minimized the cost of generating.

1.2 Literature Review

1.2.1 Arbitrage Study in Power Market

The model in this thesis is strongly connected to the research about financially motivated price manipulations in power market. In the paper [9], researchers studied aggregators' strategic behavior in the power market and proposed that aggregators can chase their profits by choosing cost parameter. The oligopoly of aggregators may be detrimental to consumers. Study [10] indicates even though aggregators are beneficial to power systems, there is a possibility that they may abuse their market power. This paper proposed a pricing scheme that encourages aggregators to act in a socially optimal manner and aggregators' profits are under supervision.

As for the resilience strategy, reference [11] proposed an optimal bidding model that can keep power prices steady for avoiding the risk of profit loss. Researchers in [12] studied the uncertain market prices and used CVaR to manage the risk of aggregator participation. Study [13] shows a game theoretic model that studied the competition between aggregators and DSOs to maximize the profits of all units in the power market.

This thesis also has close relationship with cyber security in power market which studies how a malicious party manipulates prices and realizes arbitrage by injecting false data to the power systems [14]-[20]. Researchers in the studies [14], [18] and [19] indicate the malicious parties can attack the sensor data and compromise the state measurement in the power system which can bring profits to them. Articles [15] and [16] show that these attacks can influence both system security and power prices by causing line congestions.

1.2.2 Economic Power Dispatch after LMP Manipulation

In the modern power system, the consequences of malicious manipulations have received close attention to in recent years [21]-[22]. Many studies have proposed strategies that avoid these operations, but quickly reacting after the fact is also important. In [23], authors proposed an algorithm of managing distributed units based on neighborhood watch in order to solve economic

dispatch when the generators are compromised. Without a central coordinator, this method can perform a reliable distributed control and ensure the accurate control calculation.

In this thesis, we adopted the traditional economic dispatch based on DC power flow model when the curtailment of generation happens and ignored the transmission loss. There are some research considering grid loss when solving economic dispatch problem. Jianxing *et al* [24] proposed a new economic dispatch model based on AC/DC iteration to reduce the transmission loss.

1.2.3 Locational Marginal Price

Locational marginal pricing is the main way in power market to determine the bus price which is influenced by line congestions. The author in [3] outlined the basic characteristics of both day-ahead power market and real-time market. They also presented the fundamental LMP calculation which can provide effective price signals and support the network running in a reliable way.

LMPs can be calculated by the simulation based on AC optimal power flow (ACOPF) or DC optimal power flow (DCOPF) [25]. Xu and Overbye [26] showed a LMP decomposition model based on ACOPF. Li and Bo [27] proposed a fictitious nodal demand model based on DCOPF to

calculate the LMP. Davari [28] presented an algorithm based on Two Point Estimate Method (T-PEM) to calculate the mean and variance of LMP.

1.3 Thesis Objectives and Contributions

1.3.1 Research Objectives

- To know clearly how the aggregator of distributed generators increases profit through financially motivated price manipulation.
- Build a mathematic model to know the most profitable curtailment point for the aggregator and apply it into a power system.
- Propose a resilience strategy to take precautions against the financially motivated curtailment and keep LMPs steady in the whole system.

1.3.2 Summary of Contributions

This thesis proposes the potential price manipulation through financially motivated generation curtailment by aggregators in the power market and a resilience strategy to take precautions against it. We use a tri-level mathematic model to optimize the extra profit of aggregators based on updated generation dispatch and LMP calculating.

After that, we apply the model into IEEE 14-bus power system and acquire the most profitable curtailment point for the aggregator. The result shows that after the curtailment, most LMPs in the system are changed. Also when the generators that make up the financially motivated curtailment are different, the profits of the aggregator are different.

We assume that the aggregator does not know exactly which generators make up the curtailment and we use expectation strategy and robust optimization to conduct the most suitable generation curtailment point for the aggregator.

In the end, we proposed using backup generators to keep LMPs steady when the curtailment happens and decrease the motivation for the aggregator to do the financially motivated generation curtailment. At the same time, we figure out the most suitable place to put the backup generators.

2 Tri-level Model of the Optimizing Curtailment Profit

Aggregators can easily control the generation output in modern system which cause the possibility that they can curtail the generation from their units and lead to higher LMPs. Through this process, they can realize the arbitrage. In this section, we proposed a new mathematic tri-level model for simulating the financially motivated price manipulation process based on economic power dispatch and the calculation of LMPs. In this thesis, we assume the aggregator knows all information related to the power system, including network topology and state estimates.

2.1 Structure of the Tri-level Model

Aggregators play important roles in the development of constructing sustainable power grids. They provide interface points for ISOs to interact with distributed renewable generators and have a significant share in the power market. Therefore, the electricity market is easily influenced by the manipulation of aggregators. They have the chance to curtail the generation that belongs to them to heighten the LMP and make profits.

The goal of curtailing generation is to maximize the increased profit of aggregators subjected to generation limitation, under the logical assumption that ISO will do the economic dispatch action to minimize the whole operation fee in the system based on the changed generation outputs.

A tri-level model shown in Fig. 2-1 is proposed to identify the relationship between the curtailment amount and the increased profit of aggregators.

The upper level represents the aggregator and determines the generation vector to be curtailed in order to maximize the aggregator's interest. Because the optimal objective function is nonconvex, i.e. it cannot be solved by common solvers, we adopted traversal search method to find out the most profitable curtailment point of generation.

The independent system operator (ISO) in the second level problem optimally reacts to the changed generation output that has been successfully operated by the curtailment vector determined in the first level. In this thesis, the reaction only includes economic power redispatch because load shedding is costly and usually will not be used by ISOs. The aim of economic power redispatch is to minimize the system operating fee of the system under the balance of energy production and load demands. In our model, we adopted the traditional economic power dispatch only considering the generating fee and ignoring the transmission fee.

As for the last level of the whole model, it is the algorithm that calculates LMPs based on the new generation dispatch. After the whole process, the new LMPs return to the first level and the

aggregator's increased profit comes out. At the same time, the LMPs in the whole power system are changed by the aggregator.

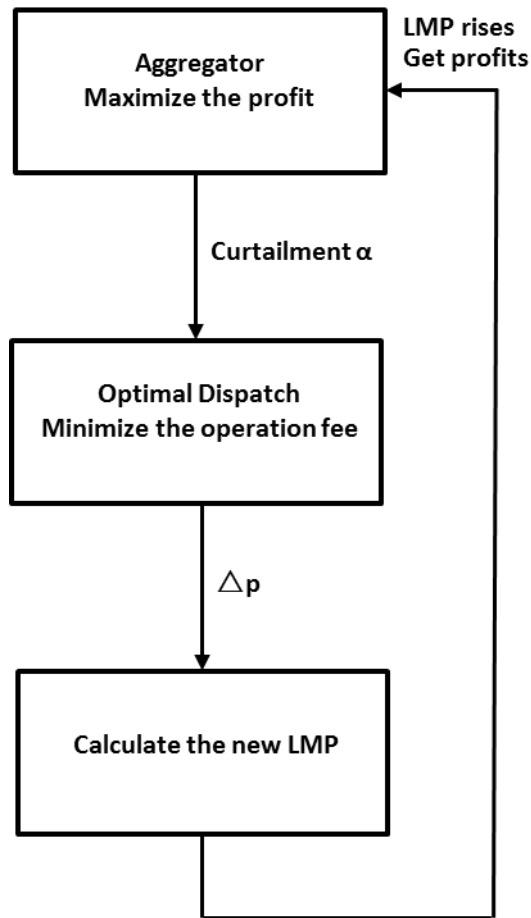

Figure 2-1 Tri-level model for price manipulation

As in most LMP manipulation research of the electricity systems, we use DC power flow model to identify the behavior of the aggregators and system operators.

2.2 The Aggregator Behavior of the Generation Curtailment

In the power system, aggregators play a role between generators and electrical customers as an individual part, collecting and selling power to residents, especially renewable energy. However, because of the complex and numerous renewable resource systems, it is not easy to regulate aggregators in the power market against making profits illegally [29]. Aggregators can curtail generation outputs on purpose and make their profit bigger than before without being noticed. It is possible to realize this change in profit because in the real-time market the LMP of the bus that aggregator manages is going to be higher with the strategy of curtailment even though its generation output decreases. Then there will be a big difference in their profits.

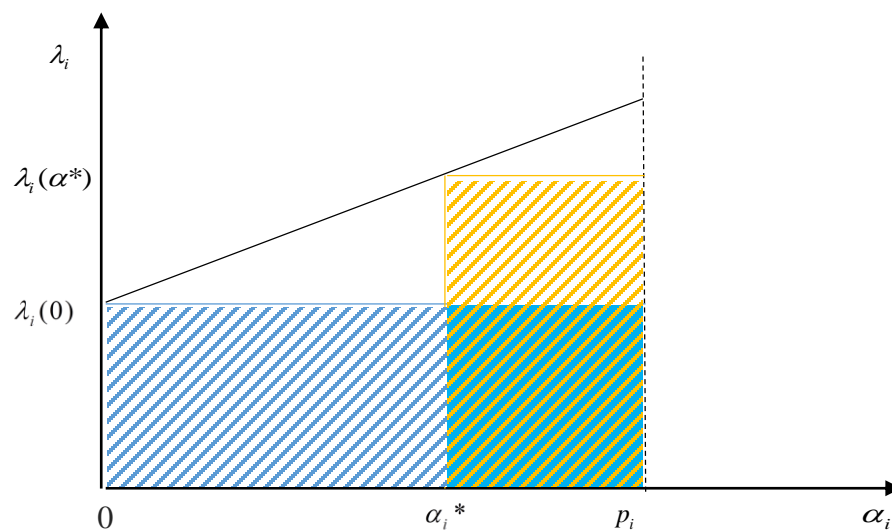

Figure 2-2 The comparison of profits after the generation curtailment [2]

We assume the LMP at bus i monotonically increase with the generation decreasing at that bus which is controlled by the aggregators. In Fig. 2-2, $\lambda_i(0)$ is the original LMP at bus i and p_i is the original generation at bus i . α_i^* is the generation curtailment at which point the aggregator can get the maximum profit and $\lambda_i(\alpha^*)$ is the corresponding LMP. The two shaded areas indicate the revenue that the aggregators get before and after the generation curtailment [2]. The difference between them is the extra profit through the generation curtailment [2]. If the yellow area is bigger than the blue one, the aggregator can acquire positive profits and the optimal generation curtailment happens at the point that the yellow area is the biggest [2].

In a power system, consider there are n buses and t transmission lines. We use $p = [p_1, \dots, p_n]^T$, $d = [d_1, \dots, d_n]^T$ and $f = [f_1, \dots, f_t]^T$ to denote the generation outputs, loads and the flow of lines respectively. Assume the generation of node i can be managed by the aggregator. For not being penalized, the aggregator needs to limit his curtailment of generation by ε , which is denoted by α_i , where $0 \leq \alpha_i \leq \varepsilon$. The aim of the aggregator is to maximize their profit difference caused by the generation curtailment and the first level of our model can be formulated as below:

$$\text{Max } \sum \lambda_i(p_i - \alpha_i) - \sum \lambda_{0i} \cdot p_i \quad (2.1)$$

$$\text{Subject to } 0 \leq \alpha_i \leq \varepsilon \quad (2.2)$$

In the objective function (2.1), λ_i is the new LMP at bus i after the curtailment which can be obtained after the process of the third level model. $\sum \lambda_{0i} \cdot p_i$ means the original profits of the aggregator and $\sum \lambda_i (p_i - \alpha_i)$ indicates the profits after the curtailment. The difference value of them is the increased profit of the aggregator. Both α_i and λ_i are variables and the function is non-convex. Therefore, we use the traversal method to change the value of α_i from zero to the upper limit curtailment of generation to realize the optimal problem.

The cost change of generation is ignored in this model because in most cases the renewable generation cost is close to zero. It should be noted that the optimal result can be both positive and negative numbers. If it is positive, it means that the system is profitable for the aggregators.

2.3 Economic Power Dispatch

In the power system, when a generation output at a bus declines, other generators will make up the curtailment. If not, the system frequency will fall and it violates the strategy of the power system. At the same time, it is better to not shed loads because of the expensive fee. In this thesis, we use optimal power dispatch with limited generators and compare different combinations of available generators to make up the curtailment of generation to proof that the maximum profit point for the aggregator is not unique.

In this section, we assume bus i belongs to the buses at which the generators are controlled by the aggregators and bus l belongs to the buses at which the generators are available to make up the financially motivated generation curtailment. α_i is the curtailment that designed by the aggregator in the first level model. Therefore, in this level it is used as a constant. The aim of economic power dispatch is to minimize the generating cost of the whole system. The second level of our whole model can be written as below:

$$\text{Min}_{\Delta\beta_l} \quad -\sum c_l \Delta\beta_l \quad (2.3)$$

$$\text{Subject to} \quad \alpha_i + \sum \Delta\beta_l = 0 \quad (2.4)$$

$$\Delta\beta_l \leq 0 \quad (2.5)$$

$$\underline{f} \leq G(p - \Delta\gamma - d) \leq \bar{f} \quad (2.6)$$

$$p - \Delta\beta_l \leq \overline{Pg}_l \quad (2.7)$$

In the objective function (2.3), $\Delta\beta_l$ is the opposite value of the added generation output at bus l for making up the curtailment and c_l indicates the offer price of the generator at bus l from ISO. $-\sum c_l \Delta\beta_l$ means the new generating cost of the power whose amount is the same as the curtailment.

Constraint function (2.4) enforces the whole generation of the system unchanged to meet the load demand. Because $\Delta\beta_i$ is the opposite value of the generation output, all the values of them are less than zero in the function (2.5). In the constraint function (2.6), \underline{f} and \bar{f} indicate the lower and upper line limits and $G \in \mathbb{R}^{t \times n}$ is the generation shifting factor matrix of the power system. d indicates the actual value of the load. $\Delta\gamma$ is a matrix of n rows and 1 columns including α_i and $\Delta\beta_i$, and the other values are zero. After the financially motivated generation curtailment by the aggregators, the generation output of each bus can be denoted by $p - \Delta\gamma$. Then the flow of lines can be denoted by $f = G(p - \Delta\gamma - d)$. In the constraint function (2.7), \overline{Pg}_i indicates the upper generation limit at bus i .

2.4 LMP Model Based on Generation Curtailment

In the power market, ISO acquires the real-time generation, load demand and flows of the system from the state estimation during every interval generation dispatch. Based on this information, ISOs minimize the total cost for operating the whole power system with an optimization model which can conduct the LMPs. The model for calculating the LMPs based on generation curtailment by aggregators can be written as below:

$$\text{Min}_{\Delta p} \quad c^T \Delta p \quad (2.8)$$

$$\text{Subject to} \quad \sum \Delta p_i = 0 \quad (\lambda) \quad (2.9)$$

$$\underline{\Delta p} \leq \Delta p \leq \overline{\Delta p} \quad (\lambda^-, \lambda^+) \quad (2.10)$$

$$\underline{f} \leq G(p - \Delta \gamma + \Delta p - d) \leq \overline{f} \quad (\mu^-, \mu^+) \quad (2.11)$$

In the above functions, it should be noted that $\Delta \gamma$ is a constant matrix that obtained from the second level model and $p - \Delta \gamma$ indicates the new power dispatch. In the objective function (2.8), Δp is the change in power output for generators. Constraint function (2.9) keeps the whole generation of the system unchanged. In the constraint function (2.10), $\underline{\Delta p}$ and $\overline{\Delta p}$ indicate the lower and upper limits on the change of generations. Usually, we default $\underline{\Delta p}_i = -2$ and $\overline{\Delta p}_i = 0.1$, $\forall i$ [30]. Constraint function (2.11) ensures the flows are valid. Variables $\lambda, \lambda^-, \lambda^+ \in \mathbf{R}_+^n$, $\mu^-, \mu^+ \in \mathbf{R}_+^t$ are the dual variables (Lagrange multipliers) corresponding to function (2.9), (2.10) and (2.11).

The locational marginal price of node i with the generation curtailment α_i can be denoted by $\lambda_i(\alpha)$ as below:

$$LMP = c + \lambda^+ - \lambda^- + B(\mu^+ - \mu^-) \quad (2.12)$$

Here $B \in \mathbb{R}^{n \times t}$ is the pseudo inverse matrix of G .

In this thesis, we use the updated LMP based on the generation curtailment to conduct the profit of the aggregators. Therefore, we need to transform the function (2.8)-(2.11) into Lagrange form (dual form) for getting the value of Lagrange multipliers to calculate the LMPs. The transformed model can be written as:

$$\text{Min} \quad \overline{\Delta p}^T \lambda^+ - \underline{\Delta p}^T \lambda^- + (G(d - p + \alpha) + \overline{f})^T \mu^+ - (G(d - p + \alpha) + \underline{f})^T \mu^- \quad (2.13)$$

$$\text{Subject to} \quad c + \lambda + \lambda^+ - \lambda^- + G^T(\mu^+ - \mu^-) = 0 \quad (2.14)$$

$$\lambda^+, \lambda^-, \mu^+, \mu^- \geq 0 \quad (2.15)$$

After the calculation of new LMPs, we can apply it into the first level model and get the increased profit of the aggregator at a certain curtailment of generation. Then we can use the traversal method to figure out the most profitable curtailment point of the aggregator.

3 Case Study

In this section, we implemented the tri-level model mentioned in the section 2 in the IEEE 14-bus power system which shows in Fig. 3-1 [31] to illustrate the financially motivated LMP manipulation process. We proposed 11 cases in which the available generators that make up the curtailment of generation are different. For each case, we figured out the most profitable point at which the aggregator curtail the generation. We also analyzed the power price fluctuation after the process. At the end we use both expectation value and robust optimization to conduct the most suitable curtailment point of the aggregator without knowing which case is used by the ISO.

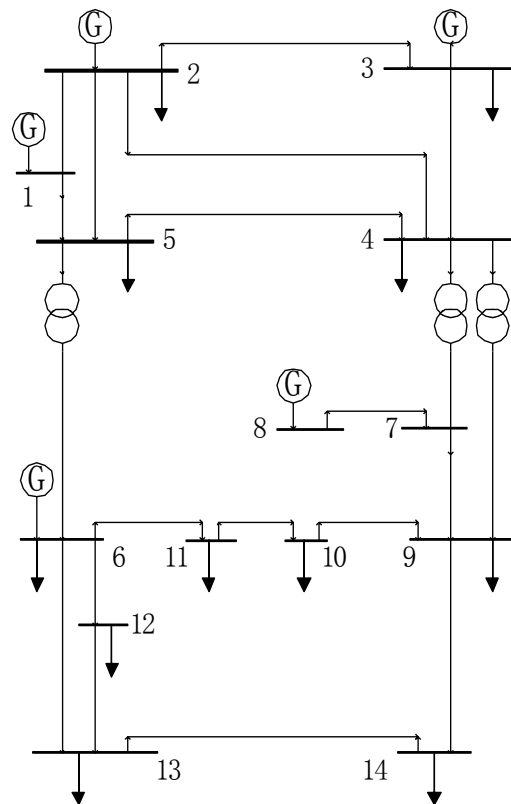

Figure 3-1 IEEE 14-bus power system [31]

3.1 Data Set

As for IEEE 14-bus power system, in this thesis we only adopted the shifting factor matrix in MATPOWER and other data are set by ourselves for creating the congestions in the system which can influence locational marginal prices. In this way, the result we get will be more suitable to show the price fluctuations after the curtailment.

The information we assume should be subject to the DC optimal power flow and other system constraint conditions. For minimizing the whole cost of generating in the system, we proposed a mathematic model to know the generation output of each generator based on the loads we set and other system information. It can be written as below:

$$\text{Min} \quad c^T \mathbf{p} \quad (3.1)$$

$$\text{Subject to} \quad \sum(\mathbf{p} - \mathbf{d}) = \mathbf{0} \quad (3.2)$$

$$\mathbf{0} \leq \mathbf{p} \leq \overline{Pg_i} \quad (3.3)$$

$$\underline{f} \leq \mathbf{G}(\mathbf{p} - \mathbf{d}) \leq \overline{f} \quad (3.4)$$

In this model, \mathbf{p} is a variable. Function (3.2) keeps the balance of generations and loads. Function (3.3) limits the generation of each units. Function (3.4) keeps the power flows within

their bounds. After this process, we will use the obtained p as a constant into our main tri-level model.

The information we set that are related to the power system is the values that are shown in Table 3-1, 3-2 and 3-3, including the generation outputs, original offer prices, generator capacities, loads, and line capacities. G and B in this system are shown in appendix A.

Bus	1	2	3	6	8
Generation Output (MW)	400	252	92	264	75
Original Offer Price (\$/MWh)	20	25	28.7	25	35
Generator Capacity (MW)	400	500	400	500	400

Table 3-1 System information- generation outputs, original offer prices and generator capacities

Bus	1	2	3	4	5	6	7
Load (MW)	75	100	50	120	60	100	70
Bus	8	9	10	11	12	13	14
Load (MW)	70	90	50	98	70	80	50

Table 3-2 System information- loads

Line	1	2	3	4	5	6	7
Line Capacity (MW)	200	150	200	150	200	250	100
Line	8	9	10	11	12	13	14
Line Capacity (MW)	150	150	250	200	150	200	250
Line	15	16	17	18	19	20	
Line Capacity (MW)	300	150	150	150	150	100	

Table 3-3 Line capacities

In this thesis, we assume there is an aggregator that has the ability to control the generation output at bus 1 through curtailing the solar or wind generation, i.e. $i=1$. Also, we set the maximum limit of generation curtailment ε is 4 MW.

3.2 Case 1 – All the Other Generators are Available

Before the generation manipulation, the aggregator does not know which generator is available to make up the curtailment. In this section, we assume all the other aggregators are available, i.e. $l \in \{2,3,6,8\}$. Using the information in the 3.1 part we get the relationship between the curtailment of generation at bus 1 and the new LMP at bus 1, which is shown in Fig. 3-2. Based on the LMPs, we can acquire the increased profit of the aggregator with the curtailment growing. It is shown in Fig. 3-3.

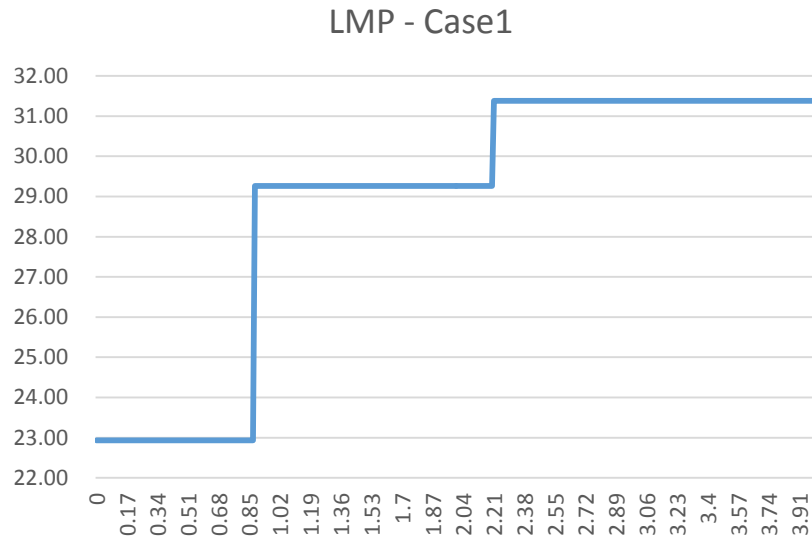

Figure 3-2 The relationship between LMP and curtailment – generators at bus 2, 3, 6, 8 are available to make up the curtailment

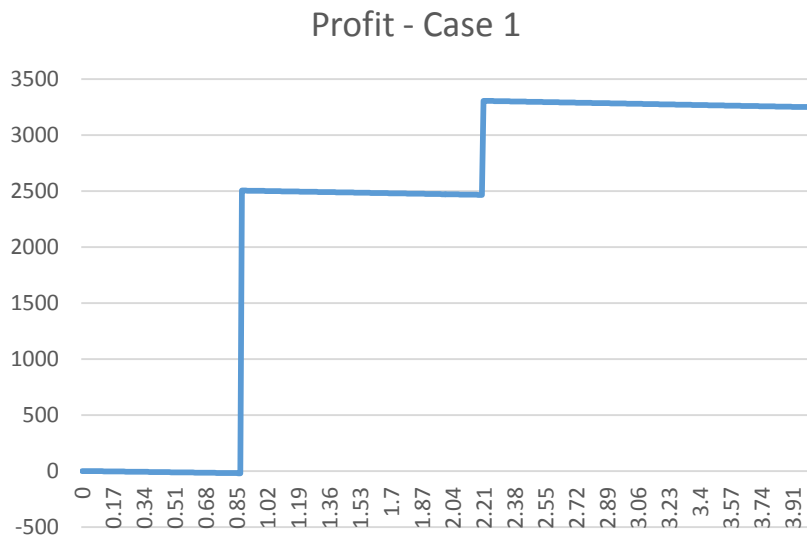

Figure 3-3 Profit caused by generation curtailment – generators at bus 2, 3, 6, 8 are available to make up the curtailment

From Figure 3-2, we can see that without the curtailment, the LMP at bus 1 is 22.94 \$/MWh which is different from the original offer price because there are some lines carrying their maximum flow and causing congestions. With the curtailment α increasing, the LMP at bus 1 following rises monotonically in a staircase way. This is because if the binding constraints of the third level of our model keep steady, the dual variables corresponding to them do not change and the LMP keeps the same in this period [2]. However, when a constraint becomes binding/non-binding, the LMP rises to another level [2].

In Fig. 3-3, it should be noted that the profit of aggregator decreases from the point that the LMP jumps to a new level. Because during the period the LMP keeps the same but the generation output decreases. From this conclusion, we can conduct that the most profitable point happens at the jump point of LMP.

As for this case, we can see from the figures that when the aggregator curtail 2.21MW (from 400MW to 397.79MW) power at bus 1, he can get $31.38 \times 397.79 - 22.94 \times 400 = \3306.57 , which is a significant profit for the aggregator. After the financially motivated curtailment, the LMP at bus 1 increases from 22.94 \$/MWh to 31.38 \$/MWh.

However, the aggregator not only influences the LMP at node 1 but also other LMPs at different buses, which can cause a significant price fluctuation in the whole power market. Fig. 3-4 shows the LMP differences at all the buses in the system before and after curtailing 2.21MW generation at bus 1.

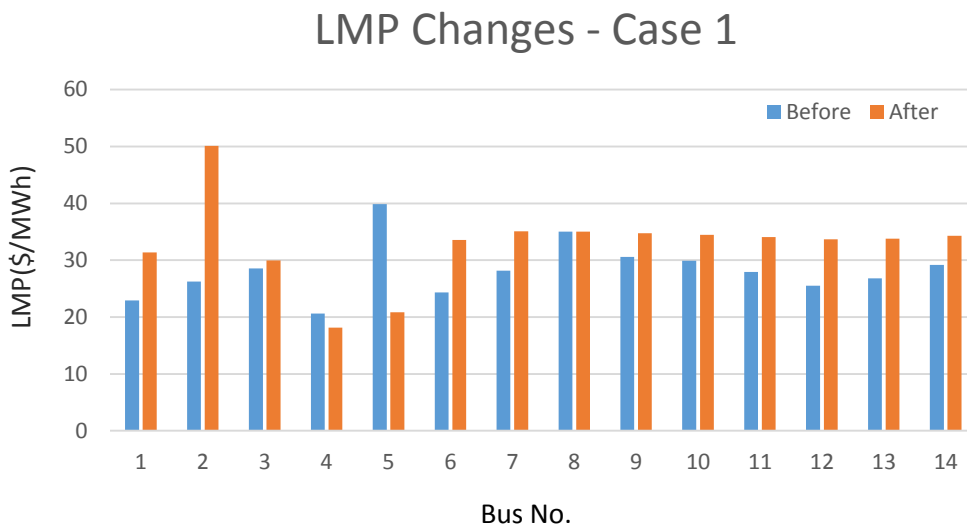

Fig. 3-4 The LMP changes at different buses after the curtailment – generators at bus 2, 3, 6, 8 make up the curtailment

From Fig. 3-4, we can see that the curtailment of generation at bus 1 causes most LMPs in the power system increased and only the LMPs at bus 4 and 5 decline. Because in our system, the original offer price at bus 1 is the cheapest. If the generation at bus 1 declined there must be other more expensive generators to make it up which causes the increasing trend in the LMPs.

From the results we get, it can be seen that the financially motivated operation of the aggregator can influence most of the LMPs in the system which can bring more profit for him. But at the same time, it may lead to an extra cost for running the whole power system or even cause some congestions and other problems to parts of the system.

3.3 Case 2 –The Generators at Bus 3, 6, 8 are Available

In this case, except for the generator at bus 2, we let all other generators in the power system be available to make up the curtailment of generation caused by the aggregator, i.e. $l \in \{3, 6, 8\}$. Fig. 3-5 shows the relationship between the curtailment of generation at bus 1 and the new LMP at the same bus based on the information mentioned in the 3.1 part. Fig. 3-6 shows the increased profit of the aggregator with the curtailment growth.

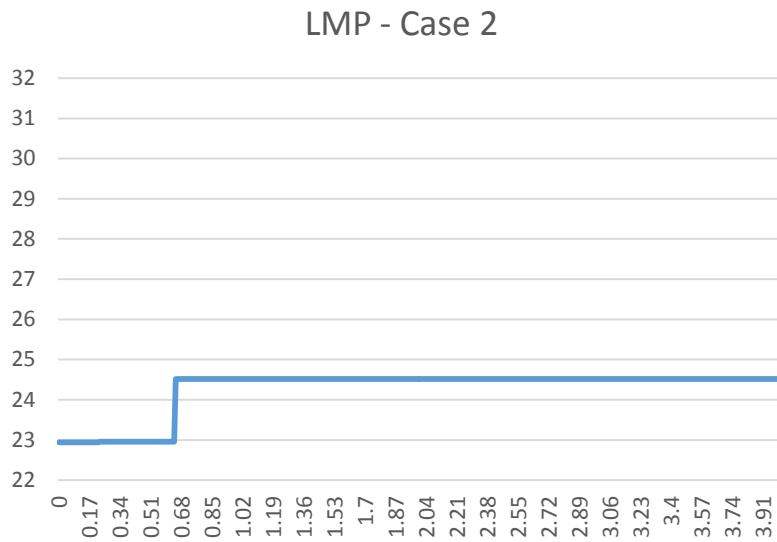

Figure 3-5 The relationship between LMP and curtailment – generators at bus 3, 6, 8 are available to make up the curtailment

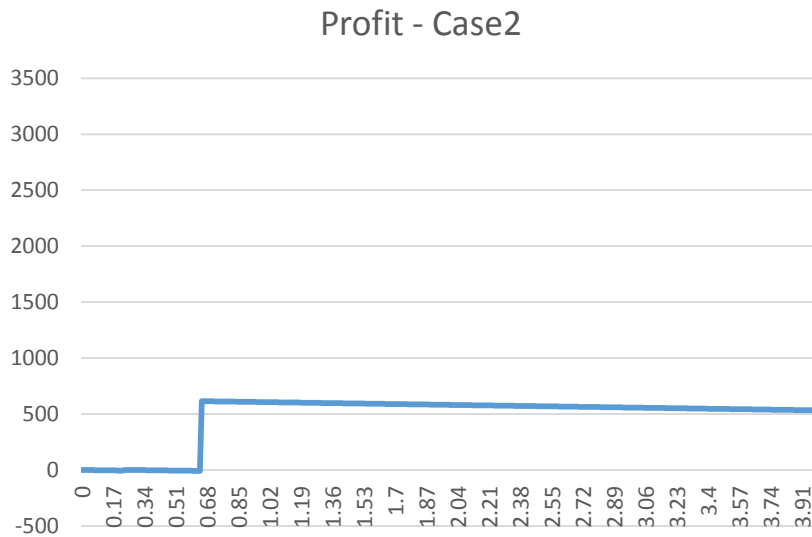

Figure 3-6 Profit caused by generation curtailment – generators at bus 3, 6, 8 are available to make up the curtailment

From the above figures, we can see that the trends of LMP at bus 1 and the profit of aggregator are similar with case 1. The most profitable point at which the aggregator curtails the generation also happens at the LMP jumping points because the LMP keeps the same value and the generation output at bus decreases.

However, the value results in this case are totally different with the ones in case 1. It can be seen that in this case, when the aggregator at bus 1 curtail 0.65MW power, the maximum profit is only \$614.83 compared with \$3306.57 in case 1. LMP at bus 1 changes from 22.94 \$/MWh to 24.51 \$/MWh which is much lower than 31.38 \$/MWh in case 1 after the curtailment of generation. The only difference between case 1 and case 2 is the combination of generators of making up the curtailment is different. Therefore, there is also possibility that the aggregator cannot get substantial profit after the financially motivated LMP manipulation under specific economic power redispatch.

As for the LMPs in the whole power system, it is the same with case 1 that most of LMPs are changed after the financially motivated curtailment at bus 1. Fig. 3-7 reports the LMP changes at different buses when the curtailment of generation at bus 1 is 0.65MW.

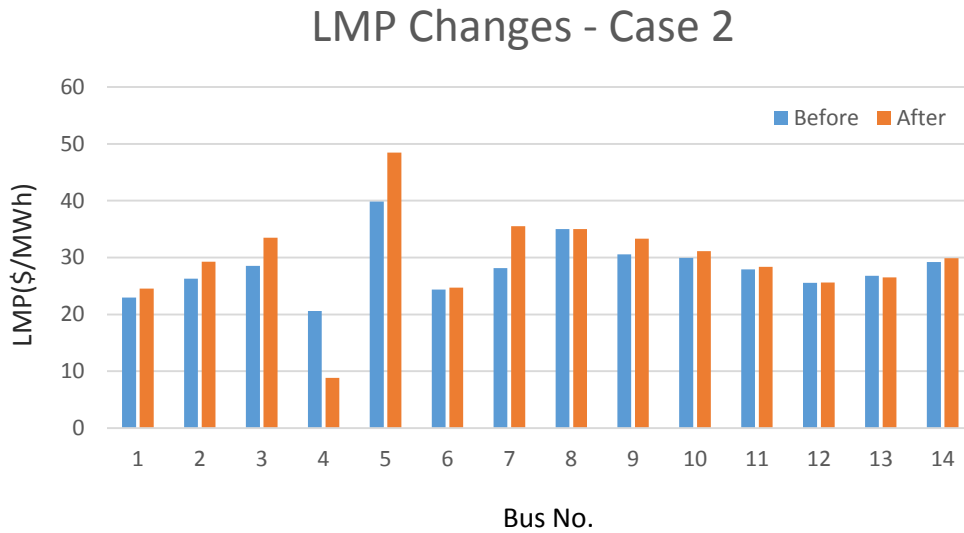

Fig. 3-7 The LMPs at different buses before and after the curtailment – generators at bus 3, 6, 8 make up the curtailment

However, the price fluctuation in the case is not as significant as case 1 even though most of them increase. Under this case, the influence of the financially motivated curtailment is not very serious. Therefore, we can see that the economic power redispatch plays an important role in this problem and it directly determines the profit of the aggregator. At the same time, the power redispatch influences the LMP changes in the system. For avoiding the significant price fluctuation in the power system, we proposed a resilience strategy that shown in detail in the next section.

3.4 Other cases

In this section, we analyze the other 9 cases that are shown in Table 3-4. We did not consider the case that there is only one generator to make up the curtailment of generation at bus 1. Because in this way it will take the risk that the generator cannot fulfill the generation demand subjected to its capacity or line congestion will occur when doing the power redispatch.

Case	The buses at which the generators are available
Case 3	2, 6, 8
Case 4	2, 3, 8
Case 5	2, 3, 6
Case 6	2, 3
Case 7	2, 6
Case 8	2, 8
Case 9	3, 6
Case 10	3, 8
Case 11	6, 8

Table 3-4 Different cases

After applying the tri-level model to all the cases mentioned above with the information in 3.1, we get the relationship between the curtailment of generation at bus 1 and the new LMP at the same bus which are separately showed in Fig. 3-8 – Fig. 3-16.

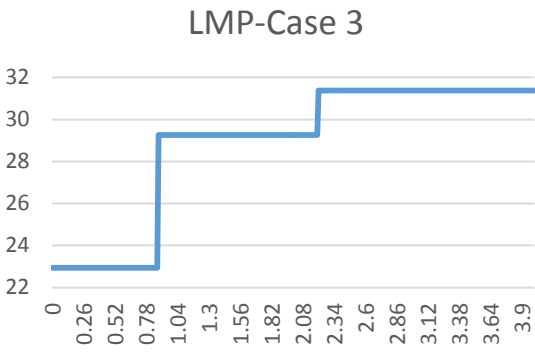

Figure 3-8 LMP changes– case 3

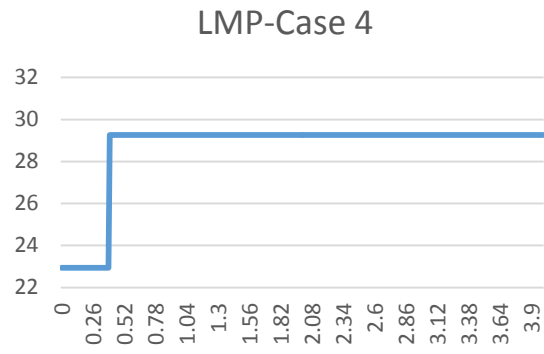

Figure 3-9 LMP changes– case 4

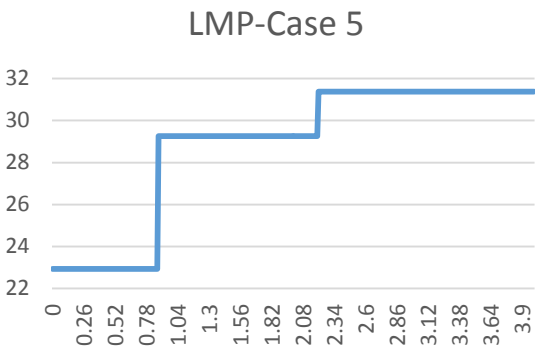

Figure 3-10 LMP changes– case 5

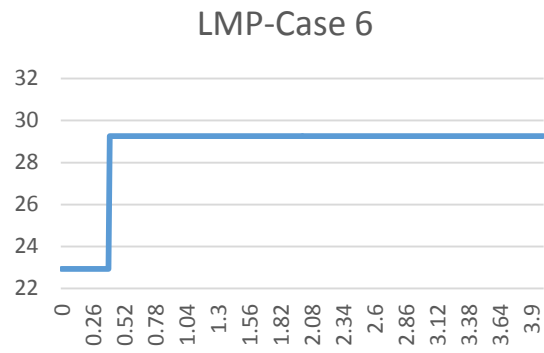

Figure 3-11 LMP changes– case 6

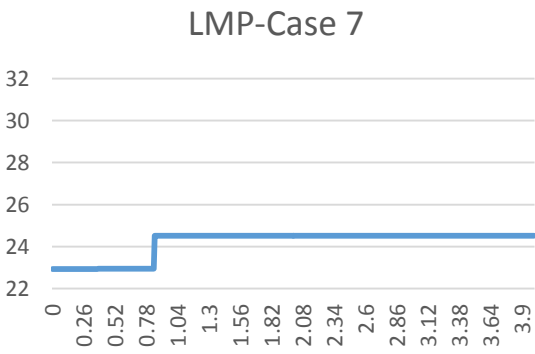

Figure 3-12 LMP changes– case 7

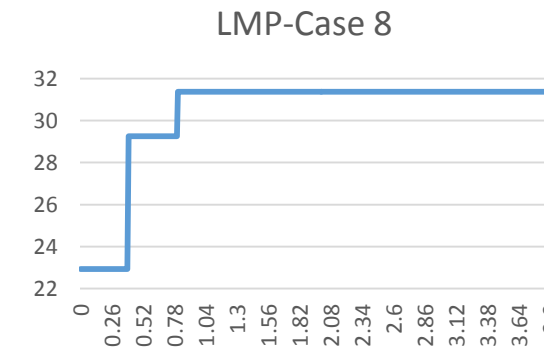

Figure 3-13 LMP changes– case 8

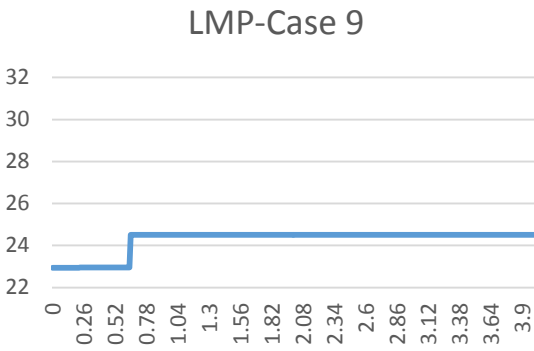

Figure 3-14 LMP changes– case 9

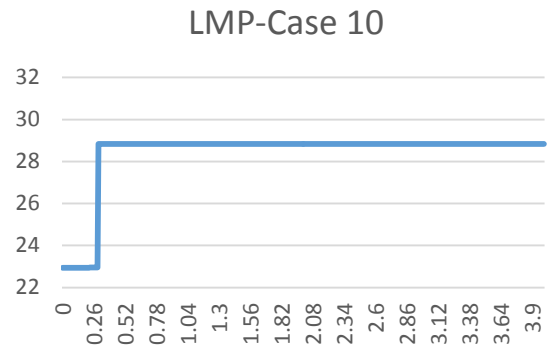

Figure 3-15 LMP changes– case 10

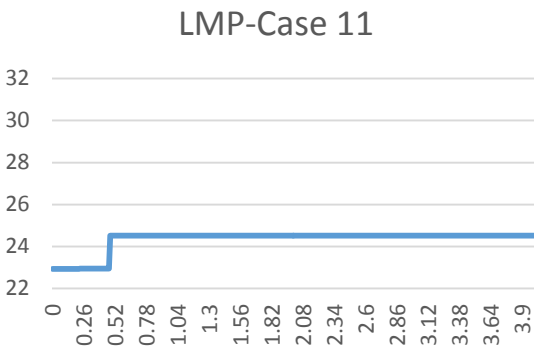

Figure 3-16 LMP changes– case 11

From the above figures, we can see that the all the original prices at bus 1 is 22.94 \$/MWh when there is no curtailment because the generation dispatch is the same in all the cases. The trends of the LMP at bus 1 in all the cases are the same with case 1 that it rises monotonically in a staircase way with the curtailment α increasing. However, when the curtailment of generation increases to its limit 4MW, the LMPs at bus 1 in all the cases vary from 24.51\$/MWh to 31.38\$/MWh. It should be noted that all the LMPs at bus 1 have changed after the financially motivated curtailment.

Based on the updated LMP at bus 1, Fig. 3-17 – Fig. 25 correspondingly show the increased profit of the aggregator with the curtailment growing in different cases.

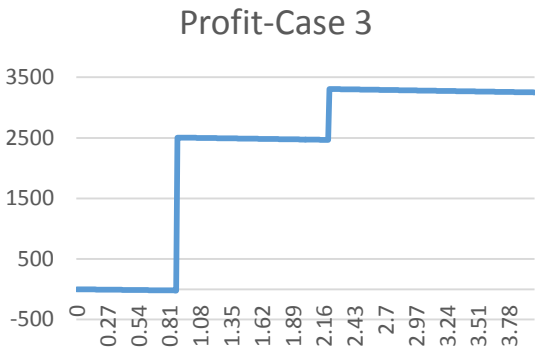

Figure 3-17 Profit changes– case 3

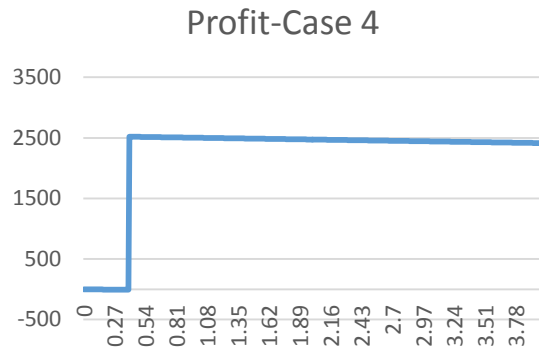

Figure 3-18 Profit changes– case 4

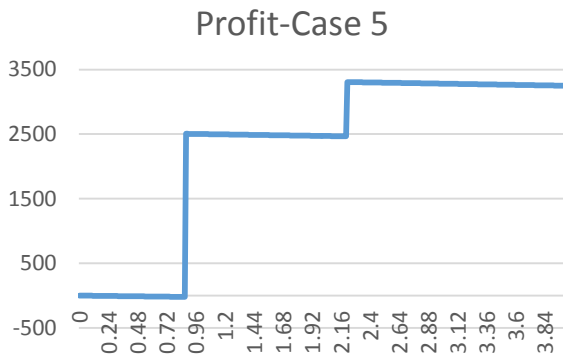

Figure 3-19 Profit changes– case 5

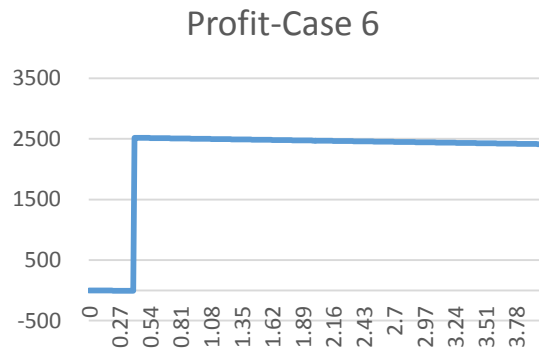

Figure 3-20 Profit changes– case 6

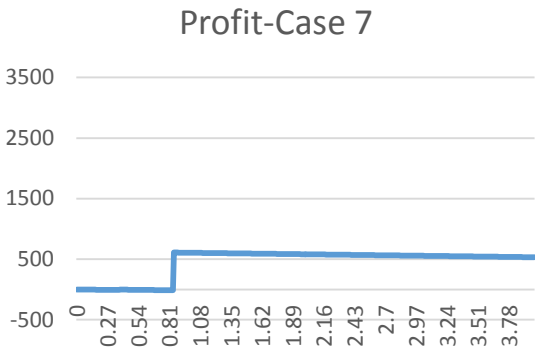

Figure 3-21 Profit changes– case 7

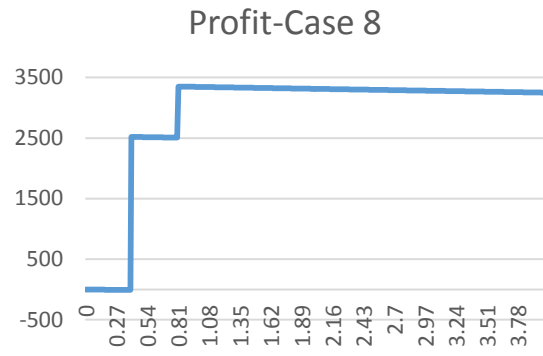

Figure 3-22 Profit changes– case 8

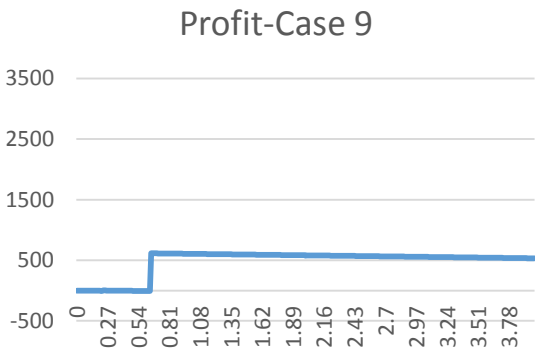

Figure 3-23 Profit changes– case 9

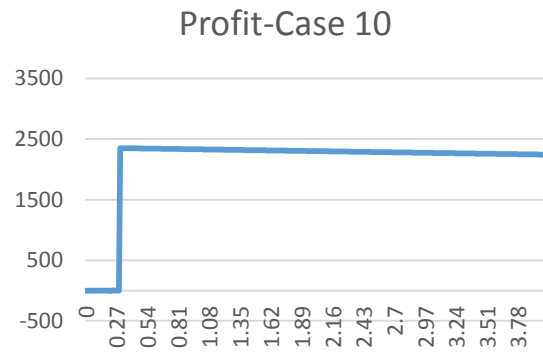

Figure 3-24 Profit changes– case 10

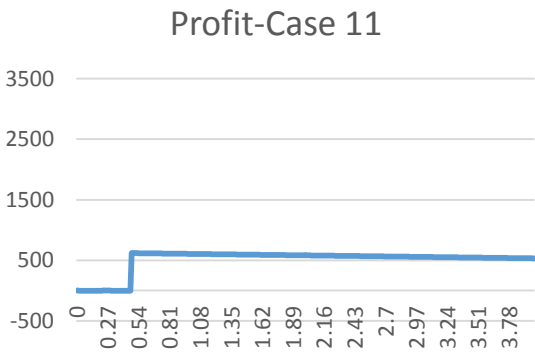

Figure 3-25 Profit changes– case 11

From the figures we can see that the trends of the increased profits of the aggregator are similar with the LMPs' that rise monotonically in a staircase way with the curtailment of generation at bus 1 increasing. However, the difference is that the profits decies after the jump points compared with the steady LMPs. The most profitable curtailment points are also at the LMP jump points.

Based on all the results we get in the 11 cases, we organized the most profitable curtailment points of the aggregator and their profits by the financially motivated LMP manipulation. They are showed in Fig. 3-26 and Fig. 3-27.

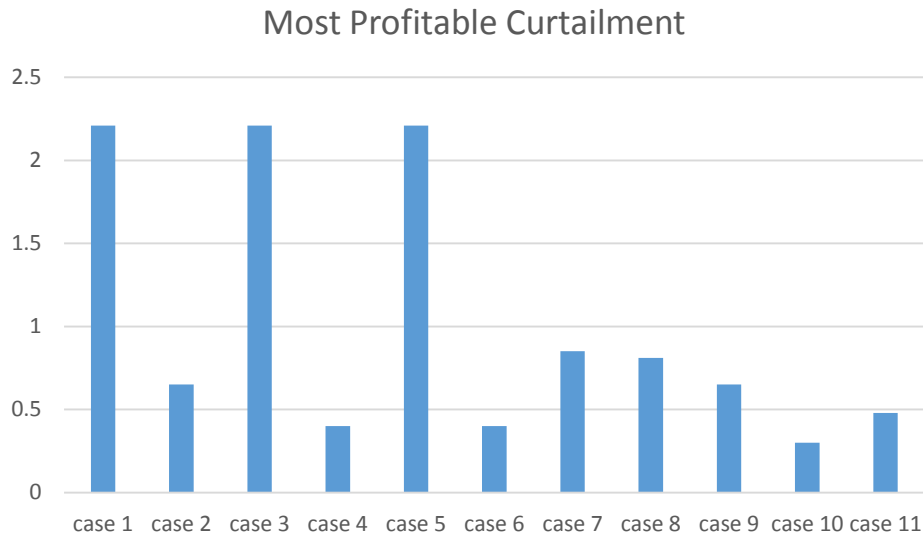

Fig. 3-26 The most profitable curtailment points in different cases

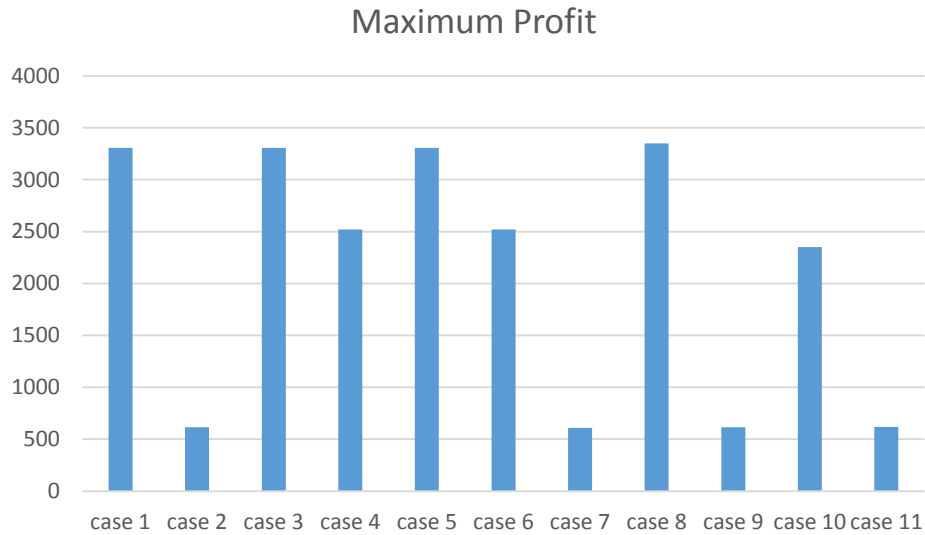

Fig. 3-27 The maximum profits of the aggregator in different cases

Firstly, we can see that when the ISO uses different generators to make up the financially motivated curtailment of generation in our second model, the increased profits of aggregator vary from \$609.93 to \$3350.50. They are a big difference. However, it should be noted that in most cases, the profit of aggregator is significant.

From Fig. 3-26, it can be seen that in most cases, when the curtailment of generation is around 0.5MW, the aggregator can get the maximum profit. However, in 3 cases, the aggregator need to curtail more than 2MW to obtain the maximum profit. This figure also indicates that when the ISO adopts different power redispatch strategy, the aggregator needs to curtail different amount of generation at bus 1 to make significant profit.

3.5 The most suitable curtailment strategy

In the last section, we already know the most profitable point for each case. But as for the aggregator, he does not know exactly which case is adopted by the ISO. Therefore, we need to conduct the most suitable curtailment point for the aggregator under this situation. In this section, we use two ways to solve this problem and they are expectation strategy and robust optimization respectively.

3.5.1 Expectation Strategy

We assume that the possibility for each case mentioned in the above section is totally equal, i.e. $p_c = 1/11$, $c = 1, 2, \dots, 11$. Then, when the generation curtailment is α , the expectation value of the profit can be expressed as:

$$E = \sum p_c w_c^\alpha \quad c = 1, 2, \dots, 11 \quad (3-5)$$

Here, w_c^α indicates the profit of the aggregator based on case c when the curtailment is α .

Using this function, the expectation profit of the aggregator at different amount of curtailment generation can be conducted and it is shown in Fig. 3-28.

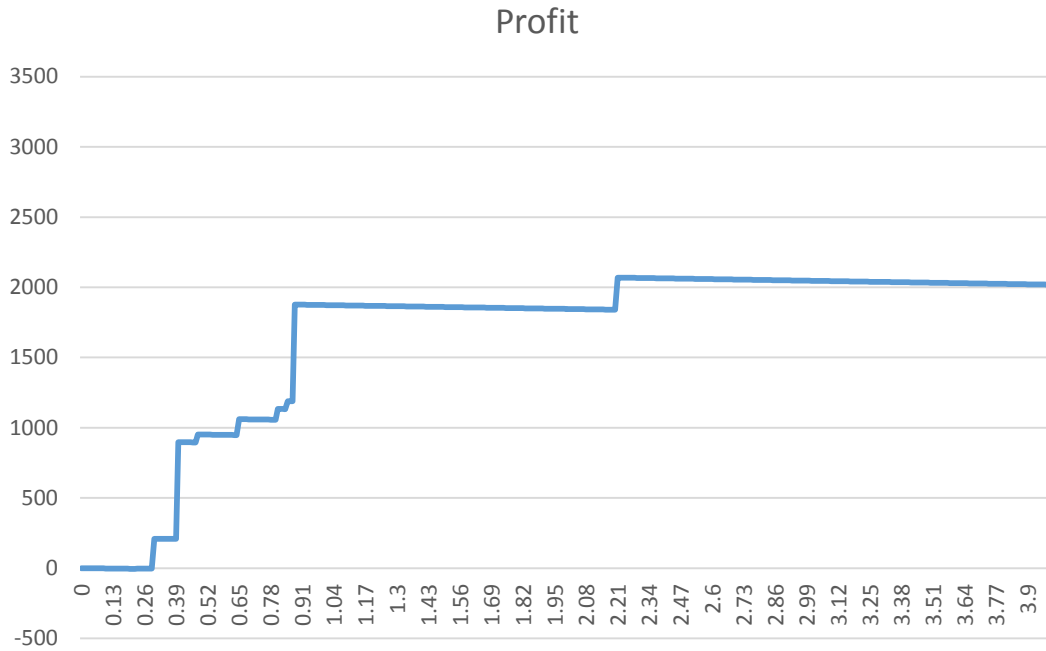

Fig. 3-28 The expectation profit of the aggregator with different curtailments

In Fig. 3-28, it can be seen that the trend of aggregator's profit is increasing with the curtailment of generation growing at bus 1. In this case, the most profitable point of the aggregator is when the curtailment of generation is 2.21MW and the expectation profit is \$2069.23.

3.5.2 Robust Optimization

Robust optimization is another strategy for the aggregator considering how to curtail the generation. But it is somewhat conservative because they will choose the worst profit through all the cases when the curtailment is α . Afterwards, they can find the most profitable curtailment point from no curtailment to curtailing 4MW generation. It can be described as the function below:

$$\max_{\alpha} \min_S \lambda(p - \alpha) - \lambda_0 \cdot p \quad (3-6)$$

Here, S is the subset of the combination of all the 11 cases mentioned above. Fig. 3-29 shows the relationship between the aggregator's profit and curtailment of generation with robust optimization.

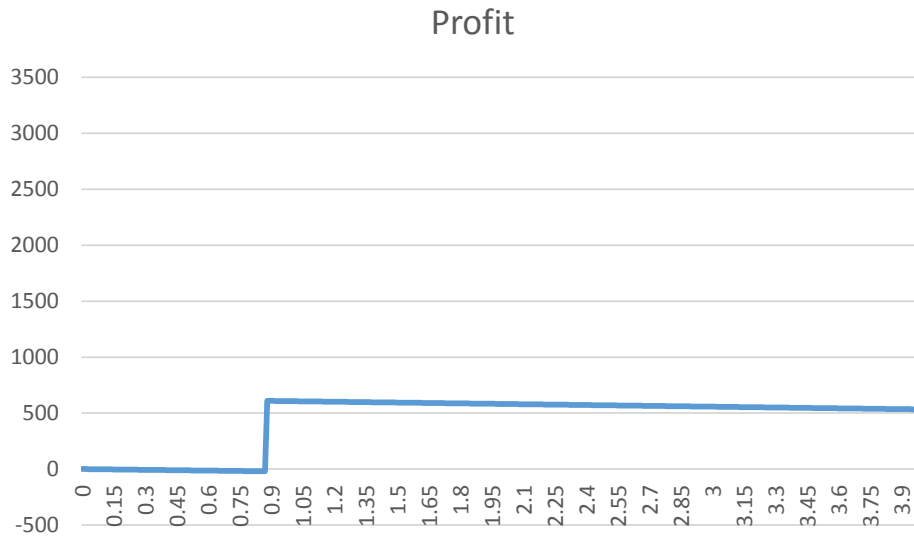

Fig. 3-29 The aggregator's profit with different curtailments under robust optimization

From Fig. 3-28, we can know that if the aggregator use robust optimization to determine how to curtail the generation, the best situation is that they can only get \$609.2 when the curtailment of generation is 0.85MW.

3.5.3 Comparison

Based on the results obtained in 3.5.1 and 3.5.2, in this part we can compare the two different strategies as Table. 3-5:

Strategy	Curtailement (MW)	Profit (\$)
Expectation	2.21	2069.23
Robust optimization	0.85	609.2

Table 3-5 The compare of the expectation strategy and robust optimization

From Table 3-5, it can be seen that the predicted maximum profit is totally different when the aggregator adopts expectation strategy and robust optimization. It is obvious that the last strategy is too conservative and it cannot suitably present the profit of aggregator because it uses the worse situation at each curtailment point. If the aggregator does not want to take risk, he may choose the robust optimization because if it curtails another amount of generation, there is possibility that it gets less profit than \$609.2.

Compared with the robust optimization, the first strategy is more reasonable to be considered by the aggregator. It considers the possibility of all the cases and deduces that maybe it can get \$2069.23 at the end. From the comparison, we can also see that for the same problem, if the

aggregator adopt different strategies to assume their potential profit, the result has a significant difference.

4 Mitigation strategy against LMP manipulation by aggregators

In the third section, we can see that in all the cases mentioned above, the aggregator can always get profits through the generation curtailment. In this section, we proposed using backup generators to make up the curtailment to take precautions against the financially motivated curtailment. The aim of the strategy is to decline the motivation of the aggregator to do it, i.e. no profit for the aggregator. Therefore, as for the system operators, they need to keep the LMPs steady even generations in the system change. We use function 4-1 to express:

$$\min || \text{LMP}' - \text{LMP} ||_2 \quad (4-1)$$

Here LMP' means the new LMP at all the buses in the system after the generation curtailment of the aggregator with the resilience strategy.

As for the same system mentioned in the third section, we assume there is a backup generator whose capacity is 2MW and the cost of running it is 10 \$/MWh at different buses. If it is under case 1 mentioned in the third section, i.e. all other generators can participate in the optimal dispatch, we need to know which bus is the best place to put the backup generator to realize our aim. Fig. 4-1 shows when the generation curtailment is 4MW at bus 1, the results of function (4-1) when the backup generator put at different buses.

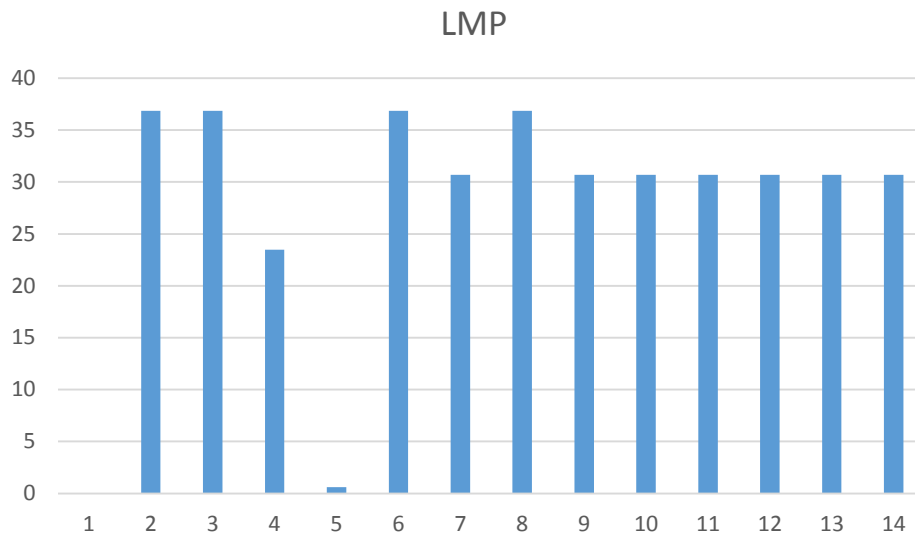

Fig. 4-1 The 2-norm of LMP changes

From the figure, we can see that when the backup generator is put at bus 1, all the LMPs at different buses keep the same with original ones. In this case, the aggregator cannot get any extra profit. Also, if the system operator puts the backup generator at bus 5, the LMPs also keep steady and there is little profit for the aggregator when they do the generation curtailment. However, if the backup generator is at other buses, the LMPs will change a lot and there is a possibility for the aggregator getting profit. Therefore, the 1st and 5th buses are the most suitable places to put the backup generator and the LMPs keep almost the same with the original one.

5 Conclusion and Future Work

Learning the possibility that aggregators of distributed generators can manipulate generation prices is crucial for the modern power market full of renewable energy. In this thesis, we use a tri-level optimal mathematic model to prove that the aggregators can get profit through the curtailment of generation. This model shows the real-time optimal dispatch of the ISO and real-time locational marginal price calculating in the power market. We find the most profitable generation curtailment point of the aggregator through applying the model to the IEEE 14-bus power system. At the same time, most of the LMPs in the whole system are changed through the curtailment and the LMP increases at the bus that aggregators control with curtailment rising.

As for the system operator, to avoid the financially motivated generation curtailment, we propose a resilience strategy to keep the LMPs steady in the whole system. We think this thesis helps to learn the power of aggregators in the power market and it can also be used to design the aggregation of renewable energy and distributed generators. From the results of this thesis, it should be noted that the system operators will be able to know how to solve this problem.

For further research, we can analyze the price manipulation influence of more than one aggregator in the power system. At the same time, improving the productivity of renewable energy

in the power system and designing the market rules of managing aggregators are also crucial problems that need to be solved.

References

- [1] Z. Lu and S. Zhou, "Integration of Large Scale Wind Energy with Electrical Power Systems in China," 10.1002/9781118910054, 2018.
- [2] N. Azizan Ruhi, K. Dvijotham, N. Chen and A. Wierman, "Opportunities for Price Manipulation by Aggregators in Electricity Markets," in IEEE Transactions on Smart Grid, vol. 9, no. 6, pp. 5687-5698, Nov. 2018.
- [3] A. L. Ott, "Experience with PJM market operation, system design, and implementation," in IEEE Transactions on Power Systems, vol. 18, no. 2, pp. 528-534, May 2003.
- [4] CME Group, "Understanding Basics of the Power Market," (n.d.) Retrieved from <https://www.cmegroup.com/education/courses/introduction-to-power/understanding-basics-of-the-power-market0.html>.
- [5] M. Salles, J. Huang, M. J. Aziz and W. W. Hogan, "Potential Arbitrage Revenue of Energy Storage Systems in PJM. Energies," 10. 1100. 10.3390/en10081100, 2017.
- [6] J. H. Chow, W. De Mello and K. W. Cheung, "Electricity Market Design: An Integrated Approach to Reliability Assurance," in Proceedings of the IEEE, vol. 93, no. 11, pp. 1956-1969, Nov. 2005.
- [7] J. D. Glover, M. S. Sarma, T. J. Overbye, "Power System Analysis and Design," 5th Edition. Cengage Learning. 2012. pp. 667.
- [8] R. C. Dorf, Section 9.3 "Automatic Generation Control," Electrical Engineering Handbook Taylor and Francis, 2006.
- [9] Y. Okajima, K. Hirata, T. Murao, T. Hatanaka, V. Gupta and K. Uchida, "Strategic behavior and market power of aggregators in energy demand networks," 2017 IEEE 56th Annual Conference on Decision and Control (CDC), Melbourne, VIC, 2017, pp. 694-701.
- [10] J. Contreras-Ocana, M. Ortega-Vazquez and B. Zhang, "Participation of an Energy Storage Aggregator in Electricity Markets," 2018 IEEE Power & Energy Society General Meeting (PESGM), Portland, OR, 2018, pp. 1-1.
- [11] X. Ge, K. Li, F. Wang and Z. Mi, "Day-ahead Market Optimal Bidding Strategy and Quantitative Compensation Mechanism Design for Load Aggregator Engaging Demand Response," 2019 IEEE/IAS 55th Industrial and Commercial Power Systems Technical Conference (I&CPS), Calgary, AB, Canada, 2019, pp. 1-8.

- [12]A. Z. Moghadam, J. Saebi and H. J. Dasht Bayaz, "Stochastic optimization of demand response aggregators in wholesale electricity markets," 2015 30th International Power System Conference (PSC), Tehran, 2015, pp. 234-240.
- [13]F. S. Gazijahani and J. Salehi, "Game Theory Based Profit Maximization Model for Microgrid Aggregators With Presence of EDRP Using Information Gap Decision Theory," in IEEE Systems Journal, vol. 13, no. 2, pp. 1767-1775, June 2019.
- [14]G. Liang, J. Zhao, F. Luo, S. R. Weller and Z. Y. Dong, "A Review of False Data Injection Attacks Against Modern Power Systems," in IEEE Transactions on Smart Grid, vol. 8, no. 4, pp. 1630-1638, July 2017.
- [15]Y. Yuan, Z. Li and K. Ren, "Modeling Load Redistribution Attacks in Power Systems," in IEEE Transactions on Smart Grid, vol. 2, no. 2, pp. 382-390, June 2011.
- [16]S. Bi and Y. J. Zhang, "False-data injection attack to control real-time price in electricity market," 2013 IEEE Global Communications Conference (GLOBECOM), Atlanta, GA, 2013, pp. 772-777.
- [17]S. Bi and Y. J. Zhang, "Using Covert Topological Information for Defense Against Malicious Attacks on DC State Estimation," in IEEE Journal on Selected Areas in Communications, vol. 32, no. 7, pp. 1471-1485, July 2014.
- [18]L. Xie, Y. Mo and B. Sinopoli, "False Data Injection Attacks in Electricity Markets," 2010 First IEEE International Conference on Smart Grid Communications, Gaithersburg, MD, 2010, pp. 226-231.
- [19]L. Xie, Y. Mo and B. Sinopoli, "Integrity Data Attacks in Power Market Operations," in IEEE Transactions on Smart Grid, vol. 2, no. 4, pp. 659-666, Dec. 2011.
- [20]Y. Liu, P. Ning, and M. K. Reiter, "False data injection attacks against state estimation in electric power grids," ACM Trans. Inf. Syst. Security, vol. 14, no. 1, p. 13, 2011.
- [21]Idaho National Laboratory, "Common cyber security vulnerabilities observed in control system assessments by the INL NSTB program," U.S. Dept. Energy Office Elect. Del. Energy Reliab., Idaho Falls, ID, USA, INL/EXT-08-13979, Nov. 2008.
- [22]M. Cheminod, L. Durante, and A. Valenzano, "Review of security issues in industrial networks," IEEE Trans. Ind. Informat., vol. 9, no. 1, pp. 277– 293, Feb. 2013.
- [23]W. Zeng, Y. Zhang and M. Chow, "Resilient Distributed Energy Management Subject to Unexpected Misbehaving Generation Units," in IEEE Transactions on Industrial Informatics, vol. 13, no. 1, pp. 208-216, Feb. 2017.

- [24] T. Jianxing, S. Bin, C. Rui, Y. Yao and W. Guosong, "Economic Dispatching Method Based on Dynamic Network Loss Factor," 2018 International Conference on Power System Technology (POWERCON), Guangzhou, 2018, pp. 601-605.
- [25] A. S. Korad and K. W. Hedman, "Reliability and stability analysis of corrective topology control actions," 2015 IEEE Eindhoven PowerTech, Eindhoven, 2015, pp. 1-6.
- [26] C. Xu and T. J. Overbye, "An energy reference bus independent LMP decomposition algorithm," in IEEE Transactions on Power Systems, vol. 21, no. 3, pp. 1041-1049, Aug. 2006.
- [27] F. Li and R. Bo, "DCOPF-Based LMP Simulation: Algorithm, Comparison With ACOPF, and Sensitivity," IEEE Trans. Power Systems, vol. 22, pp. 1475-1485, 2007.
- [28] M. Davari, F. Toorani, H. Nafisi, M. Abedi and G. B. Gharehpetian, "Determination of mean and variance of LMP using probabilistic DCOPF and T-PEM," 2008 IEEE 2nd International Power and Energy Conference, Johor Bahru, 2008, pp. 1280-1283.
- [29] S. Burger, J. P. Chaves-Ávila, C. Batlle, and I. J. Pérez-Arriaga, "The Value of Aggregators in Electricity Systems," (n.d.) Retrieved from https://energy.mit.edu/wp-content/uploads/2016/01/CEEPR_WP_2016-001.pdf.
- [30] D. B. Patton, P. LeeVanSchaick, and J. Chen, "2013 assessment of the electricity markets in new england," Potomac Econ., Fairfax, VA, USA, Tech. Rep., 2014.
- [31] I. Dabbagchi and R. Christie, "IEEE 14 Bus Test Case," (n.d.) Retrieved from labs.ece.uw.edu/pstca/pf14/pg_tca14bus.htm.

Appendix

Appendix A

$$G = \begin{bmatrix} 0.0000 & -0.8380 & -0.7465 & -0.6675 & -0.6106 & -0.6291 & -0.6573 & -0.6573 & -0.6518 & -0.6477 & -0.6386 & -0.6309 & -0.6323 & -0.6433 \\ 0.0000 & -0.1620 & -0.2535 & -0.3325 & -0.3894 & -0.3709 & -0.3427 & -0.3427 & -0.3482 & -0.3523 & -0.3614 & -0.3691 & -0.3677 & -0.3567 \\ 0.0000 & 0.0273 & -0.5320 & -0.1513 & -0.1031 & -0.1188 & -0.1427 & -0.1427 & -0.1380 & -0.1346 & -0.1269 & -0.1204 & -0.1215 & -0.1308 \\ 0.0000 & 0.0572 & -0.1434 & -0.3167 & -0.2158 & -0.2487 & -0.2986 & -0.2986 & -0.2888 & -0.2817 & -0.2655 & -0.2519 & -0.2543 & -0.2738 \\ 0.0000 & 0.0774 & -0.0711 & -0.1994 & -0.2917 & -0.2616 & -0.2160 & -0.2160 & -0.2249 & -0.2314 & -0.2463 & -0.2587 & -0.2564 & -0.2387 \\ 0.0000 & 0.0273 & 0.4680 & -0.1513 & -0.1031 & -0.1188 & -0.1427 & -0.1427 & -0.1380 & -0.1346 & -0.1269 & -0.1204 & -0.1215 & -0.1308 \\ 0.0000 & 0.0799 & 0.3067 & 0.5026 & -0.3012 & -0.0389 & 0.3584 & 0.3584 & 0.2808 & 0.2240 & 0.0948 & -0.0137 & 0.0061 & 0.1607 \\ 0.0000 & 0.0030 & 0.0113 & 0.0186 & -0.0111 & -0.2075 & -0.6338 & -0.6338 & -0.4469 & -0.4043 & -0.3076 & -0.2264 & -0.2412 & -0.3569 \\ 0.0000 & 0.0017 & 0.0066 & 0.0108 & -0.0065 & -0.1211 & -0.1658 & -0.1658 & -0.2608 & -0.2360 & -0.1795 & -0.1321 & -0.1408 & -0.2083 \\ 0.0000 & -0.0047 & -0.0179 & -0.0294 & 0.0176 & -0.6714 & -0.2004 & -0.2004 & -0.2924 & -0.3597 & -0.5128 & -0.6415 & -0.6181 & -0.4348 \\ 0.0000 & -0.0028 & -0.0108 & -0.0177 & 0.0106 & 0.1979 & -0.1207 & -0.1207 & -0.1760 & -0.2873 & -0.5402 & 0.1683 & 0.1452 & -0.0356 \\ 0.0000 & -0.0004 & -0.0016 & -0.0026 & 0.0016 & 0.0291 & -0.0177 & -0.0177 & -0.0259 & -0.0161 & 0.0061 & -0.5211 & -0.1697 & -0.0887 \\ 0.0000 & -0.0014 & -0.0056 & -0.0091 & 0.0055 & 0.1017 & -0.0620 & -0.0620 & -0.0904 & -0.0563 & 0.0213 & -0.2886 & -0.5936 & -0.3104 \\ 0.0000 & 0.0000 & 0.0000 & 0.0000 & 0.0000 & 0.0000 & 0.0000 & -1.0000 & 0.0000 & 0.0000 & 0.0000 & 0.0000 & 0.0000 & 0.0000 \\ 0.0000 & 0.0030 & 0.0113 & 0.0186 & -0.0111 & -0.2075 & 0.3662 & 0.3662 & -0.4469 & -0.4043 & -0.3076 & -0.2264 & -0.2412 & -0.3569 \\ 0.0000 & 0.0028 & 0.0108 & 0.0177 & -0.0106 & -0.1979 & 0.1207 & 0.1207 & 0.1760 & -0.7127 & -0.4598 & -0.1683 & -0.1452 & 0.0356 \\ 0.0000 & 0.0019 & 0.0071 & 0.0117 & -0.0070 & -0.1307 & 0.0797 & 0.0797 & 0.1163 & 0.0724 & -0.0274 & -0.1902 & -0.2367 & -0.6008 \\ 0.0000 & 0.0028 & 0.0108 & 0.0177 & -0.0106 & -0.1979 & 0.1207 & 0.1207 & 0.1760 & 0.2873 & -0.4598 & -0.1683 & -0.1452 & 0.0356 \\ 0.0000 & -0.0004 & -0.0016 & -0.0026 & 0.0016 & 0.0291 & -0.0177 & -0.0177 & -0.0259 & -0.0161 & 0.0061 & 0.4789 & -0.1697 & -0.0887 \\ 0.0000 & -0.0019 & -0.0071 & -0.0117 & 0.0070 & 0.1307 & -0.0797 & -0.0797 & -0.1163 & -0.0724 & 0.0274 & 0.1902 & 0.2367 & -0.3992 \end{bmatrix}$$

$$B = \begin{bmatrix} 1.1461 & -1.1069 & 0.0043 & 0.0658 & -0.1093 & -0.0003 & 0.0004 & 0.0000 & 0.0002 & -0.0004 & 0.0000 & 0.0000 & 0.0003 & -0.0001 \\ 0.4492 & 0.4031 & -0.0160 & -0.2480 & -0.5878 & 0.0011 & -0.0017 & 0.0000 & -0.0008 & 0.0016 & 0.0001 & 0.0000 & -0.0012 & 0.0005 \\ 0.0865 & 0.8830 & -0.9341 & 0.1793 & -0.2150 & -0.0008 & 0.0013 & 0.0000 & 0.0006 & -0.0012 & -0.0001 & 0.0000 & 0.0009 & -0.0004 \\ 0.1696 & 0.8933 & -0.0237 & -0.6184 & -0.4215 & -0.0016 & 0.0025 & 0.0000 & 0.0012 & -0.0024 & -0.0002 & -0.0001 & 0.0019 & -0.0007 \\ 0.1861 & 0.8938 & -0.0220 & -0.3405 & -0.7168 & 0.0014 & -0.0023 & 0.0000 & -0.0011 & 0.0022 & 0.0001 & 0.0001 & -0.0017 & 0.0006 \\ 0.0747 & -0.1011 & 1.0569 & -0.8451 & -0.1857 & -0.0007 & 0.0011 & 0.0000 & 0.0005 & -0.0011 & -0.0001 & 0.0000 & 0.0008 & -0.0003 \\ 0.0583 & -0.0498 & 0.0083 & 1.1836 & -1.1949 & 0.0126 & -0.0198 & 0.0000 & -0.0098 & 0.0191 & 0.0012 & 0.0006 & -0.0148 & 0.0055 \\ 0.0026 & -0.0023 & 0.0004 & 0.9759 & 0.1985 & -0.0539 & -0.8590 & 0.0000 & -0.2126 & -0.0818 & -0.0052 & -0.0024 & 0.0633 & -0.0236 \\ 0.0013 & -0.0011 & 0.0002 & 0.3677 & 0.0971 & -0.0264 & -0.1064 & 0.0000 & -0.3082 & -0.0400 & -0.0025 & -0.0012 & 0.0310 & -0.0116 \\ -0.0036 & 0.0031 & -0.0005 & 0.3033 & 0.7296 & -0.9266 & -0.1155 & 0.0000 & -0.0573 & 0.1113 & 0.0071 & 0.0032 & -0.0862 & 0.0322 \\ -0.0022 & 0.0019 & -0.0003 & 0.1834 & -0.1635 & 1.0095 & -0.0699 & 0.0000 & -0.1611 & 0.1405 & -0.9911 & -0.0033 & 0.0894 & -0.0334 \\ -0.0002 & 0.0001 & 0.0000 & 0.0131 & -0.0117 & 0.7469 & -0.0050 & 0.0000 & 0.0201 & -0.0082 & -0.0005 & -0.8820 & 0.1166 & 0.0108 \\ -0.0005 & 0.0004 & -0.0001 & 0.0414 & -0.0369 & 1.1633 & -0.0158 & 0.0000 & 0.0635 & -0.0261 & -0.0017 & -0.0561 & -1.1657 & 0.0342 \\ 0.0000 & 0.0000 & 0.0000 & 0.0000 & 0.0000 & 0.0000 & 1.0000 & -1.0000 & 0.0000 & 0.0000 & 0.0000 & 0.0000 & 0.0000 & 0.0000 \\ 0.0014 & -0.0012 & 0.0002 & -0.0130 & 0.1068 & -0.0290 & 1.0758 & 0.0000 & -1.1144 & -0.0440 & -0.0028 & -0.0013 & 0.0341 & -0.0127 \\ 0.0009 & -0.0008 & 0.0001 & -0.0779 & 0.0695 & -0.0041 & 0.0297 & 0.0000 & 1.0684 & -1.0597 & -0.0038 & 0.0014 & -0.0380 & 0.0142 \\ 0.0012 & -0.0010 & 0.0002 & -0.0998 & 0.0890 & -0.0715 & 0.0380 & 0.0000 & 0.8470 & 0.0628 & 0.0040 & -0.0082 & 0.2208 & -1.0824 \\ 0.0021 & -0.0018 & 0.0003 & -0.1771 & 0.1579 & -0.0092 & 0.0675 & 0.0000 & 0.1556 & 0.8643 & -1.0086 & 0.0032 & -0.0863 & 0.0322 \\ -0.0001 & 0.0001 & 0.0000 & 0.0102 & -0.0091 & -0.1977 & -0.0039 & 0.0000 & 0.0157 & -0.0064 & -0.0004 & 1.0922 & -0.9089 & 0.0084 \\ -0.0015 & 0.0013 & -0.0002 & 0.1285 & -0.1145 & 0.0920 & -0.0489 & 0.0000 & 0.1969 & -0.0809 & -0.0051 & 0.0106 & 0.7158 & -0.8940 \end{bmatrix}^T$$

Appendix B

Main Source Code

```
clear all;
clc;

A = zeros(401,1);
k=1;
for dp1=0:0.01:4

%% data
delta_p_low=[-2;-2;-2;0;0;-2;0;-2;0;0;0;0;0;0];
delta_p_up=[0.1;0.1;0.1;0;0;0.1;0;0.1;0;0;0;0;0];
Pgen_A
=[400;251.9174;92.2486;0;0;263.5010;0;75.3330;0;0;0;0;0];
d=[75;100;50;120;60;100;70;70;90;50;98;70;80;50];
G=makePTDF(case14);
f_up=[200;150;200;150;200;250;100;150;150;250;200;150;200;250;30
0;150;150;150;150;100];
f_low=[-200;-150;-200;-150;-200;-250;-100;-150;-150;-250;-200;-
150;-200;-250;-300;-150;-150;-150;-150;-100];
c=[20;25;28.7;0;0;25;0;35;0;0;0;0;0;0];

B=[..]; //show in Appendix A, omitted here

pmax=[400;500;400;0;0;500;0;400;0;0;0;0;0;0];

%% variables
dp2=sdpvar(1,1);
dp3=sdpvar(1,1);
dp6=sdpvar(1,1);
dp8=sdpvar(1,1);
dp=[dp1;dp2;dp3;0;0;dp6;0;dp8;0;0;0;0;0;0];

%% functions
OI = -c'*dp;
```

```

CI = [sum(dp(:))==0,
      dp2<=0,
      dp3<=0,
      dp6<=0,
      dp8<=0,
      f_low<=G*(Pgen_A-dp-d)<=f_up,
      0<=Pgen_A-dp<=pmax];

%% approach
option = sdpsettings('solver','cplex','savesolveroutput',1);
Diagnostics_B = optimize(CI,OI,option);
alpha=value(dp);

%% variables
lambda = sdpvar(1,1);
lambda_p = sdpvar(14,1);
lambda_n = sdpvar(14,1);
mu_p = sdpvar(20,1);
mu_n = sdpvar(20,1);

%% functions
Obj_B_du = delta_p_up'*lambda_p-delta_p_low'*lambda_n+(G*(d-
(Pgen_A-alpha))+f_up) '*mu_p-(G*(d-(Pgen_A-alpha))+f_low) '*mu_n;
Cst_B_du = [c+lambda*ones(14,1)+lambda_p-lambda_n+G'*(mu_p-
mu_n)==0,
           lambda_p>=0,
           lambda_n>=0,
           mu_p>=0,
           mu_n>=0];

%% approach
option = sdpsettings('solver','cplex','savesolveroutput',1);
Diagnostics_B_du = optimize(Cst_B_du,Obj_B_du,option);

%% values
LMP_B_du = c+value(lambda_p-lambda_n)+B*value(mu_p-mu_n);

A(k)=value(LMP_B_du(1));
k=k+1;

```

end;

The new LMP at bus 1 is in the matrix A.